



ECET 4520

***Industrial Distribution Systems,
Illumination, and the NEC***



Branch Circuits
+
Lighting Circuits
and
Switch Configuration



Lighting Circuits and Switch Locations

Circuit Allocation and Switch Locations

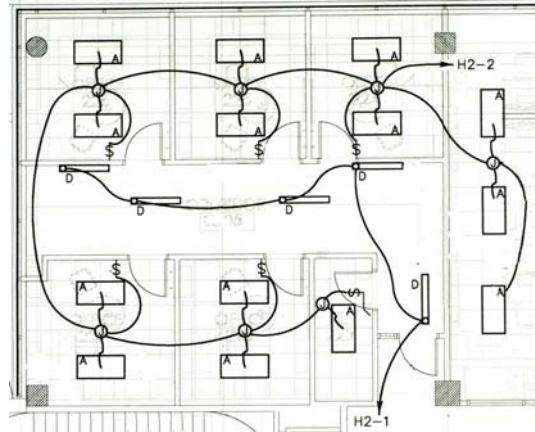

Lighting Circuits and Switch Locations

Switched Lighting with Zones

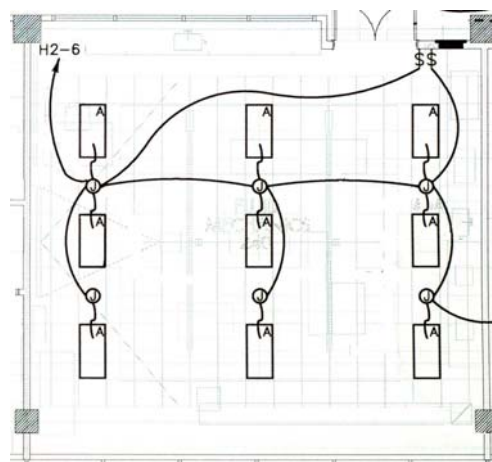





Lighting Circuits and Switch Locations

Multiply-Switched Circuits

Single-Pole Switch (S) 

Three-Way Switch (S_3) 

Four-Way Switch (S_4) 



Lighting Circuits and Switch Locations

Multiply-Switched Circuits

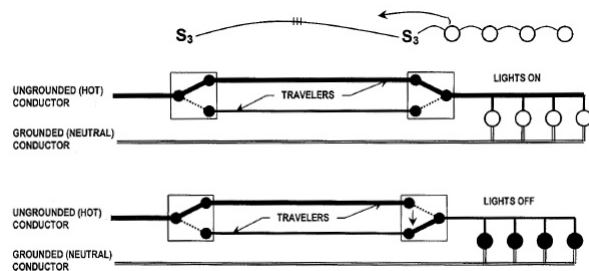



Lighting Circuits and Switch Locations

Multiply-Switched Circuits

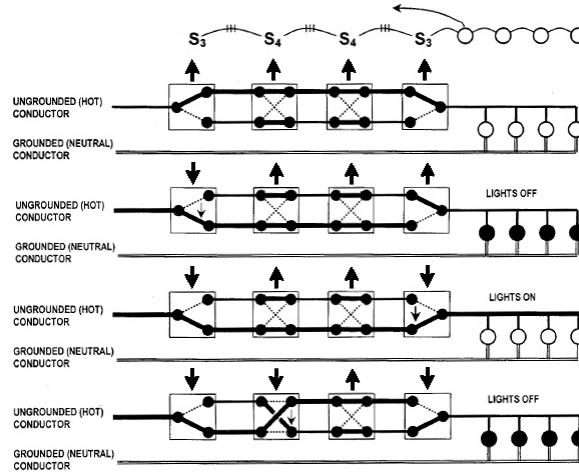

Lighting Circuits and Switch Locations

Multiply-Switched Circuits

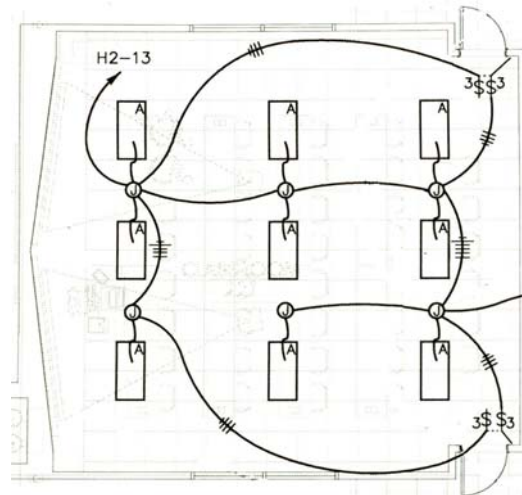



Lighting Circuits and Switch Locations

Dwelling-Unit Example (from previous PPT)

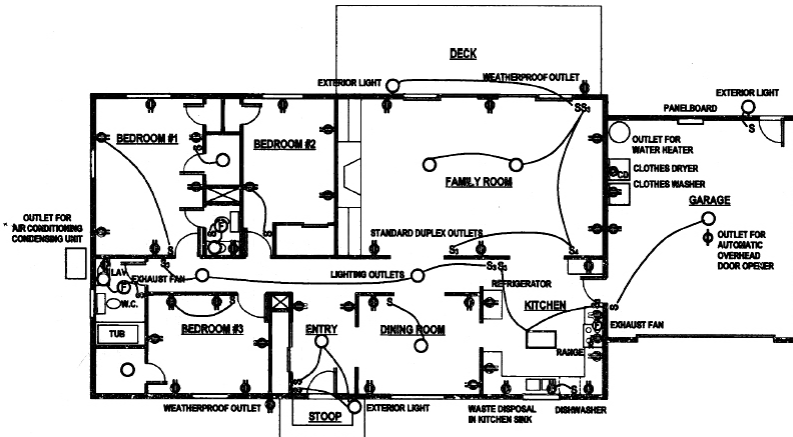

FIGURE 19.13 Layout of lighting outlets and related switches for lights and outlets for design example.



Lighting Circuits and Switch Locations

Dwelling-Unit Example (from previous PPT)

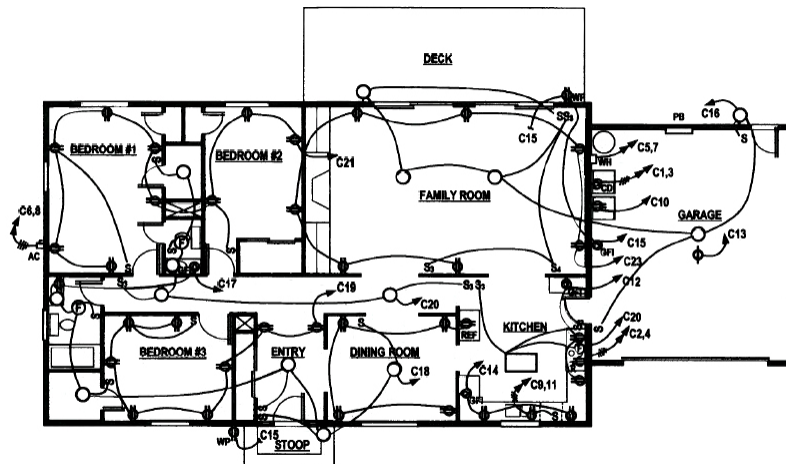

FIGURE 19.15 Circuit layout and numbering for design example.